

# 15" S-Series HMI - R15FA3S-PCC3-PoE

## Features

- 15" 1024 x 768 TFT LCD with Projected Capacitive Multi-Touch (P-CAP)
- Freescale Cortex A9 i.MX6 Dual Core 1 GHz (Optional Quad Core)
- Fanless and Ultra-low power consumption
- Onboard LPDDR3 1GB (Optional 2GB)
- Onboard 16GB eMMC Flash
- Supports PoE IEEE 802.3at (up to 25W)
- Fanless and Ultra-low power consumption
- Optional HF RFID Reader
- Front IP65 Water and Dust Proof

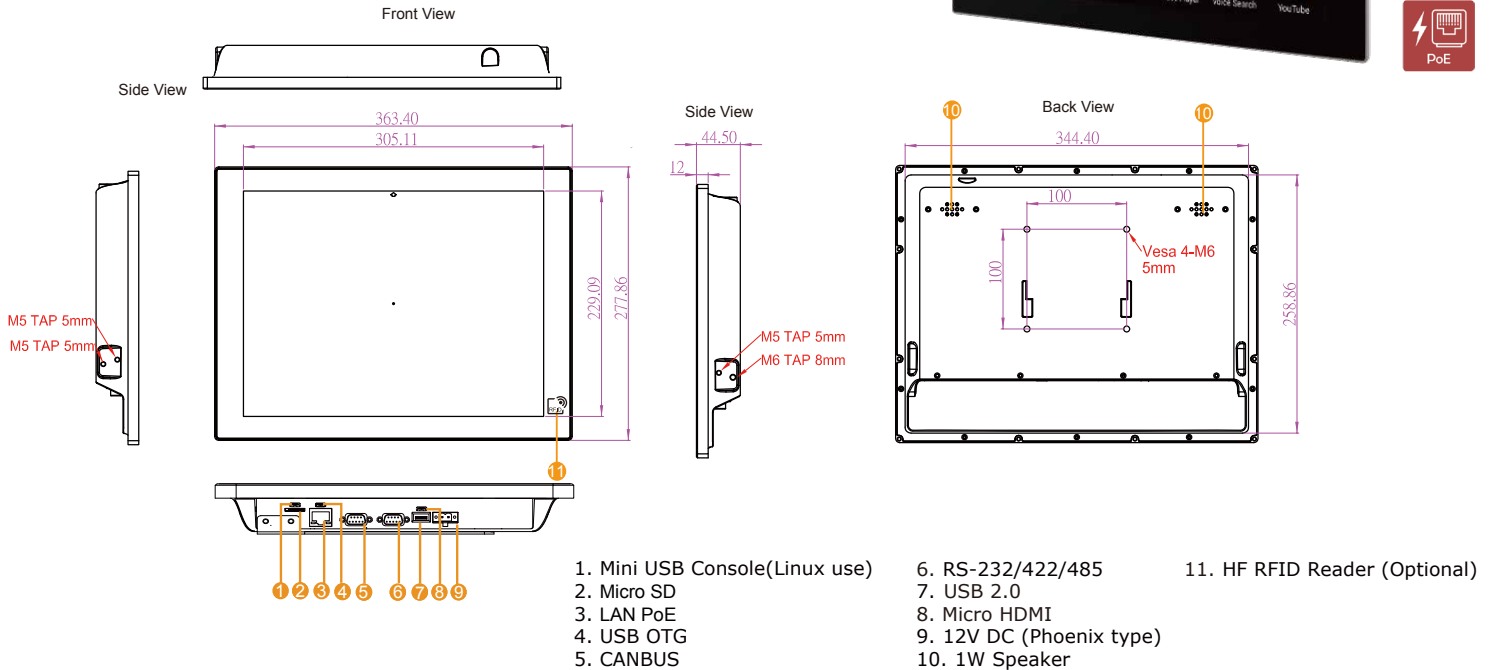

## Specifications

### System :

- Processor : Freescale Cortex A9 i.MX6 Dual Core 1GHz (Optional for Quad Core)
- Memory : 1GB LPDDR3 (Optional 2GB LPDDR3)
- Storage : Onboard 16GB eMMC ( Default )  
Micro SD Card

### Input / Output :

- COM port : 1 x RS-232/422/485
- USB Ports : 1 x USB 2.0 host, 1 x USB OTG
- SD Slot : 1 x Micro SD Card Slot
- Ethernet : 1 x RJ45,10/100/1000 LAN Support PoE function
- Speaker : 1 x 1 Watt Speaker
- CANBUS : 1 x CANBUS
- HDMI : 1 x Micro HDMI

### Power Specifications :

- Power Input : 12V DC
- Power Over Ethernet : Power Device (PD) follows IEEE 802.3at (25 W)
- Power consumption : 19W

### Operating System Support :

- Programming Guide : Android 6.0 (Default)  
Linux Kernel 4.1.15, QT5.5 (Optional)  
Ubuntu 16.04 (Optional)

### Display Spec :

- Size/Type : 15" TFT (Widescreen)
- Resolutions : 1024x768
- Brightness : 250cd/m (typ.)
- Touchinterface : Projected Capacitive Multi-Touch (P-CAP)

### Environment Considerations :

- Operating Temperature : 0 °C to 50 °C
- Operating Humidity : 10% to 90% (non-condensing)

### Mechanical Specification

- Cooling System : Fanless design
- Mounting : VESA Mount (100x100mm), Panel Mount
- Dimensions (W x H x D) : 363.4 x 277.86 x 44.5 (mm)
- Cutout Dimensions (W x D): 346 x 261 (mm)

### Peripheral (Optional):

- RFID : HF RFID Reader 13.56 MHz
- Front Camera : 2MP Front Camera