

# R06IB3S-IPA1

## 6.5" Panel PC(Intel® Celeron® Bay Trial-M N2930 1.83GHz)

Mechanical Design



IP65

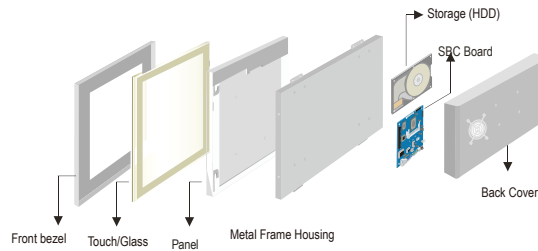

Modularized Construction

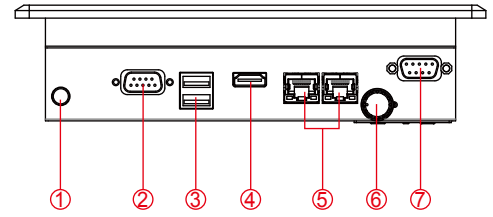

- 1. DC-in
  - 2. RS232/422/485
  - 3. USB
  - 4. HDMI
  - 5. LAN
  - 6. Brightness Adjustment
  - 7. RS232
- Default setting:RS232

FRONT VIEW

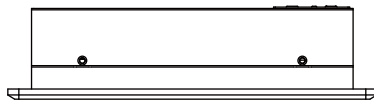

SIDE VIEW

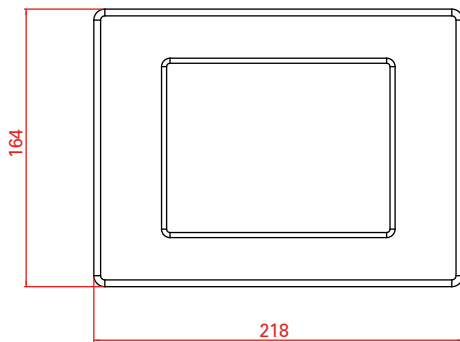
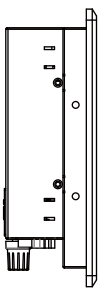

SIDE VIEW

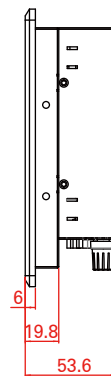

BACK VIEW

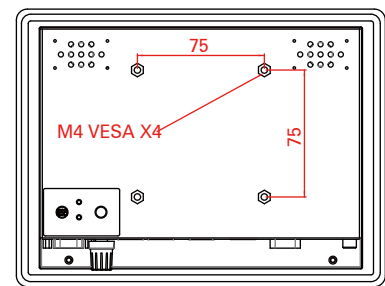

BOTTOM VIEW



\* Note: this is a simplified drawing and some components are not marked in detail. Please contact our sales representative if you need further product information.

### Specifications

#### System :

- CPU : Intel® Celeron® Bay Trial-M N2930 1.83GHz
- Memory Slot : SODIMM DDR3L 1600 Max. 8G
- System Chipset : Intel®ATOM SoC Integrated
- IDE/SATA : 1 x SATA II
- LAN : Intel® I210-AT GbE LAN x 2
- Audio Codec : Realtek ALC886 HD Audio Codec

#### Panel Spec :

- Size/Type : 6.5" TFT
- Resolutions : 640 x 480
- Brightness : 700 nits
- Contrast Ratio : 600 : 1
- Viewing Angle : -80~80 (H)-70~70(V)
- Max. Colors : 16.2M/ 262k colors

#### Input / Output :

- Serial Ports : 1 x RS232, 1 x RS232/422/485
- USB Ports : 1 x USB 3.0, 1 x USB 2.0
- Ethernet : 2 x RJ45-10/100/1000 Mbps
- HDMI : 1 x HDMI
- Power : 1 x DC-in Power Jack(+12V) ● Default setting:RS232

#### Environment Considerations :

- Operating Temperature : 0 deg.C to 50 deg.C
- Operating Humidity : 30% to 90% (non condensing)

#### OS BSP / Driver Support :

- Support Windows 10 IoT Enterprise / Windows Embedded 8 \* / Windows Embedded 7
- \*For Windows Embedded 8, this panel PC does not support the Metro UI, only the desktop mode

#### Expansion Slots:

- 1 x Mini PCIe slot (for wireless module)
- 1 x Mini PCIe slot (for SATA SSD)

#### Security Support

- Trusted Platform Module (TPM 1.2)

#### Power Specifications :

- Power Input : 12V DC-IN Power input
- Power Consumption : 25W (typ.)(Max.backlight & high CPU load)

#### Accessories :

- External Adapter : 110~240V Ac-in Power Adapter

#### Order Options :

Mechanical : IP65 (6mm bezel)	Storage : 2.5" HDD/ mSATA
Touch : 4 Wires Resistive(Optional) AR Glass (Optional)	RAM : SODIMM DDR3L 1600 Max. 8Gb
	OS : Windows 10 IoT Enterprise Windows Embedded 8 Windows Embedded 7

