

# 15" Flat Stainless P-Cap IP69K Panel PC (Intel® Celeron Bay Trail-M N2930 1.83GHz)

Flat Stainless P-Cap Chassis

MODEL #: R15IB3S-SPC369



## Features:

- 15", 1024 x 768, P-cap touch with flat design
- Intel® Celeron Bay Trail-M N2930, 1.83 GHz
- SUS304 stainless steel for food and chemical industries
- Full IP69K waterproof enclosure, good corrosion resistance
- A true flat, easy-to-clean front surface with edge-to-edge design
- Plenty of I/Os, including USB 2.0, RS232 and RJ45-10/100/1000 LAN
- Waterproof ports with adapter cables for external connectivity
- Supports VESA mount
- Supports Glove/ Rain mode (Optional)

## Waterproof connector / cable

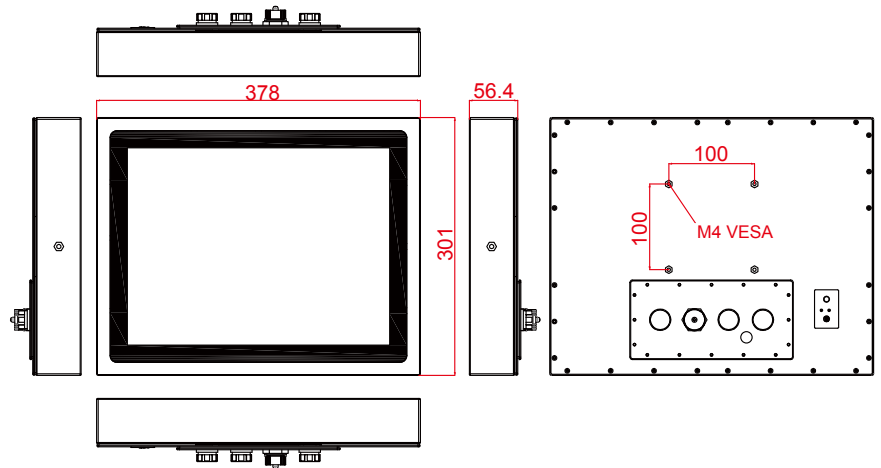
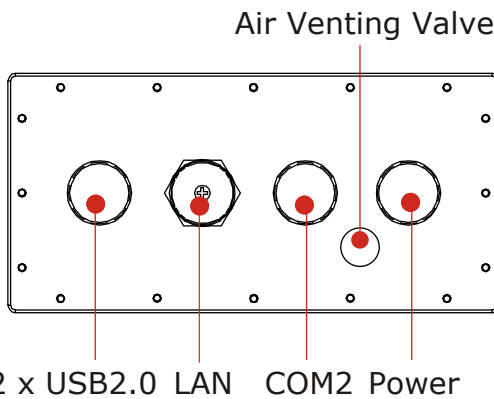

\* Note: this is a simplified drawing and some components are not marked in detail. Please contact our sales representative if you need further product information.

## System Specifications

### TFT Characteristics :

- Resolutions : 1024 x 768
- Brightness : 250 cd/m<sup>2</sup> (typ.)
- Contrast Ratio : 700 : 1 (typ.)
- Viewing Angles : -80~80(H); -70~70(V)
- Max Colors : 16.2M
- Touchscreen : P-cap (Default), Glass (Optional)

### Specifications :

- Processor : Intel® Celeron Bay Trail-M N2930 1.83GHz
- BIOS : AMI 16Mbit Flash
- System Chipset : Intel® Atom SoC Integrate
- Memory Slot : 1 x SO-DIMM, Default 4GB, Max 8GB DDR3L 1600
- Storage : Default 64GB
- Graphic Chipset : Integrated HD Graphics
- Ethernet : 2 x RJ45 Gigabit LAN (1 x RJ45 internal)
- Audio : Built in ALC886 HD Audio Codec
- USB : 6 x USB2.0 (4 x USB internal)
- Serial : 4 x RS232 (3 x RS232 internal)
- Expansion Slot : 1 x Mini PCIe (Internal)
- SSD Interface : 1 x Mini PCIe SSD
- Power Input : DC-IN (Lockable, Power Jack)
- Certification : CE, FCC, RoHS
- Security : Trusted Platform Module (TPM 1.2)

\* A customized housing is needed if you would like to have more I/O connectors

### Power Specifications :

- Power Input : 12V DC IN (Lockable Power Jack)
- Power Consumption : 38W (typ.)(Max.backlight & high CPU load)

### Environment Considerations :

- Operating Temperature : 0 deg.C to 45deg.C
- Operating Humidity : 30% to 90% (non condensing)
- IP Rating : IP69K, air venting valve

### Input/ Output Connectors :

- Ethernet LAN : 1 X RJ45 - 10/100/1000 Mbps
- COM : 1 x RS232
- USB : 2 x USB Type-A Receptacle
- Power : 1 x 12VDC

### Accessories :

- External Power Supply 80W w/power cord
- LAN Cable
- Serial Cable
- USB Cable
- VESA screws

### Order Options :

SBC	PANEL PC
RAM : SODIMM DDR3L Max 8GB	OS : Windows 10 IoT Enterprise Windows Embedded 8.1 Industry Pro Windows Embedded 8 Standard Windows Embedded 7 Standard
Storage : 2.5" HDD/Mini PCIe SSD	



# 15" Flat Stainless P-Cap IP69K Panel PC (Intel® Celeron Bay Trail-M N2930 1.83GHz)

Flat Stainless P-Cap Chassis

MODEL #: R15IB3S-SPC369

## Pin Assignment of Cables

### Power Cable

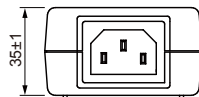
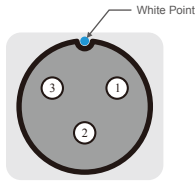
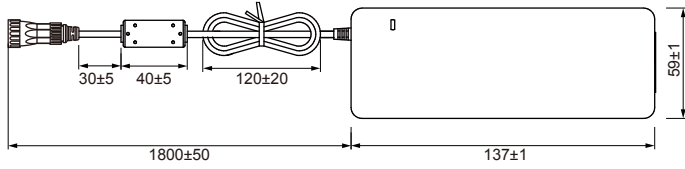

Pin No.	Symbols	Color
CN1-3	GND	Black
CN1-2	shield	
CN1-1	VCC	White

### LAN Cable

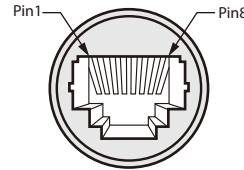
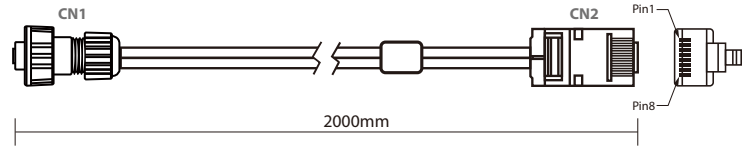

Plug	Wire Color	Conn.	
1	Orange / White	1	Twist
2	Orange	2	
3	Green / White	3	Twist
4	Blue	4	
5	Blue / White	5	Twist
6	Green	6	
7	Brown / White	7	Twist
8	Brown	8	

### Serial Cable

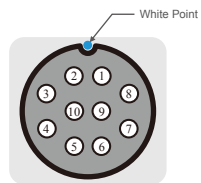
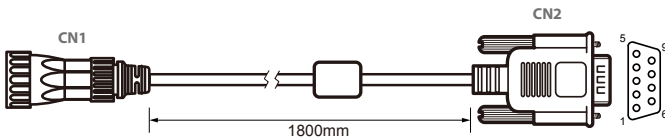

Pin No.	Symbols	Color
CN1-1	DCD-CON2	Green
CN1-2	DSR-CON2	Brown
CN1-3	RXD-CON2	Red
CN1-4	RTS-CON2	Orange
CN1-5	TXD-CON2	Blue
CN1-6	CTS-CON2	White
CN1-7	DTR-CON2	Purple
CN1-8	RI-CON2	Yellow
CN1-9	GND-CON2	Black
CN1-10	NC	

Pin No.	Symbols	Color
CN2-1	DCD-CON2	Green
CN2-6	DSR-CON2	Brown
CN2-2	RXD-CON2	Red
CN2-7	RTS-CON2	Orange
CN2-3	TXD-CON2	Blue
CN2-8	CTS-CON2	White
CN2-4	DTR-CON2	Purple
CN2-9	RI-CON2	Yellow
CN2-5	GND-CON2	Black
CN2-10	NC	

### USB Cable

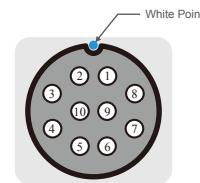
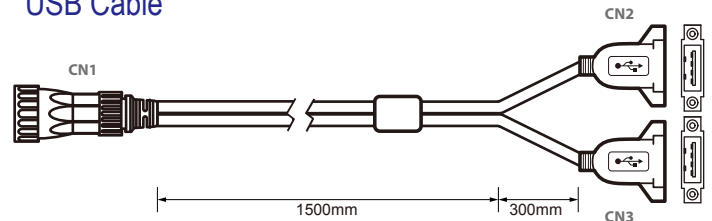

Pin No.	Symbols	Color
CN1-1	VCC	RED
CN1-2	VCC	RED
CN1-3	D-	WHITE
CN1-4	D-	WHITE
CN1-5	D+	GREEN
CN1-6	D+	GREEN
CN1-7	GND	BLACK
CN1-8	GND	BLACK
CN1-9	Braid	

Pin No.	Symbols	Color
CN2-1	VCC	RED
CN3-1	VCC	RED
CN2-2	D-	WHITE
CN3-2	D-	WHITE
CN2-3	D+	GREEN
CN3-3	D+	GREEN
CN2-4	GND	BLACK
CN3-4	GND	BLACK
Braid connect to the housing		

twisted pair

twisted pair